

【 $\phi 2.6 \times 25/32/40\text{mm}$ 】

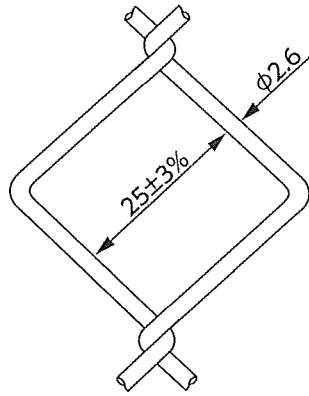

$\phi 2.6 \times 25\text{mm}$

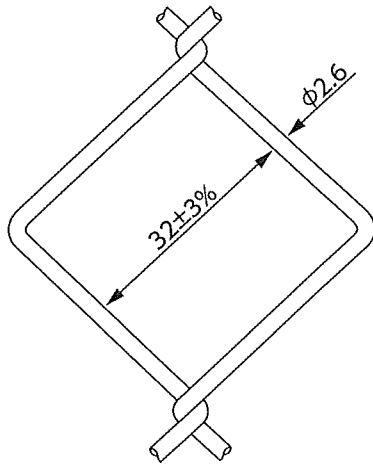

$\phi 2.6 \times 32\text{mm}$

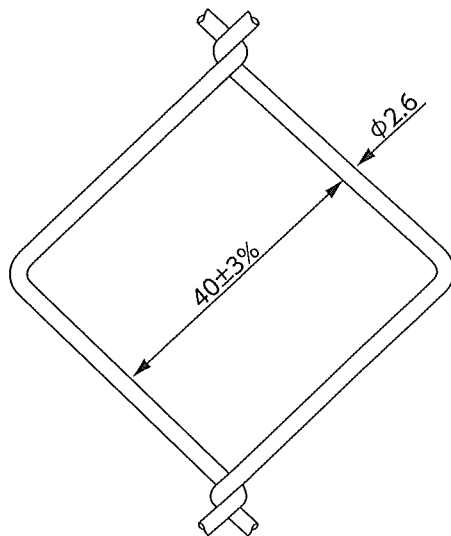

$\phi 2.6 \times 40\text{mm}$